

## SP3535-D1590N

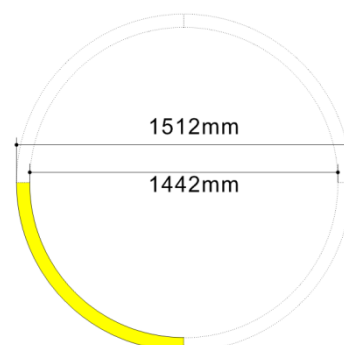

### Features

- Ever-changing shapes generated by means of super free application and connections of lines and arcs
- Flexible diffuser making it easy for installation without connections for over length application and light leakage
- AL6063-T5 aluminum profile with high-quality surface treatment and three optional colors of black, white and silver
- Specially designed light source with diffusers producing homogeneous and soft lighting
- Various installation ways: pendant and surface mounted

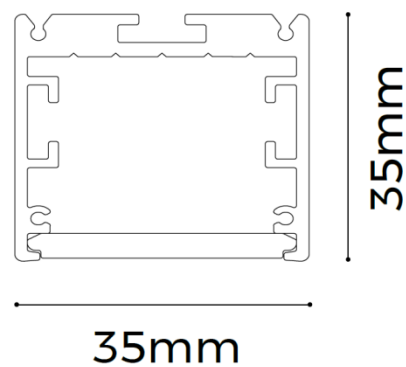

## Details

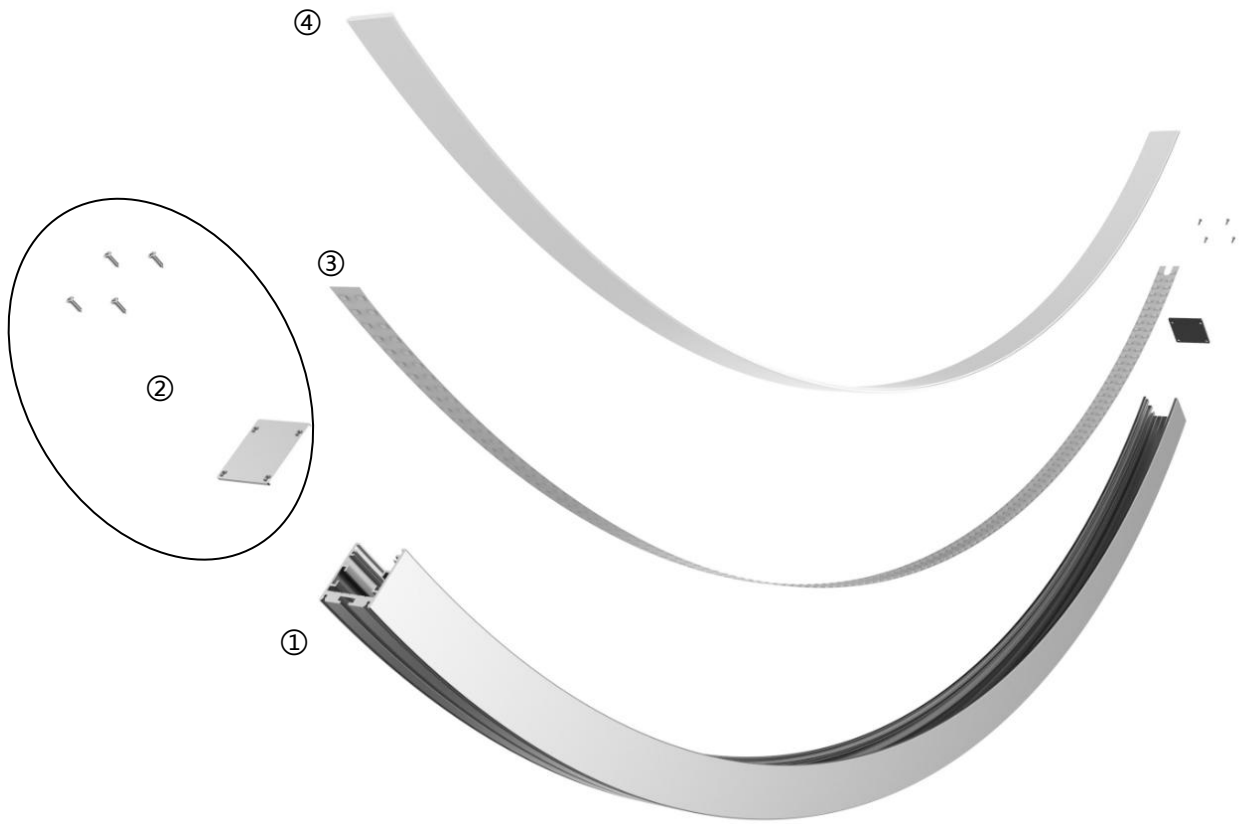

## Optional Accessories

### ① Profile:



Installation : Pendant /Surface mounted

Material : AL6063-T5

Applications: Indoors

Profile weight : 0.95kg/ D1500mm , 90°

Size : 35x35mm , D1500mm , 90°

Surface processing: Spray



### ② End cap

35\*35\*1.5mm

AL6061



### ③ Flexible strip









DC24V 7.7W/PCS(400mm) width 20mm Min. cutting unit 100mm



### ④ Diffuser

L20000mm

Diffuser

|   |                                    |                              |                                   |
|---|------------------------------------|------------------------------|-----------------------------------|
|    | Pendant cable without junction box | Steel cable D1.5*2000/4000mm |                                   |
|    | Power supply                       | ESD-V24-100S                 | 390*38*28.5mm                     |
|    | Screw set                          | M3.5*40mm                    | AL6061-T5 and Carbon steel        |
|    | straight fixed plate               | L55*W10*H2mm                 | SPCC                              |
|    | AS35-LN fixed plate                | L55*W10*H2mm                 | SPCC Straight&arc interconnection |
|    | AS35-N fixed plate                 | L55*W10*H2mm                 | SPCC Inner arc interconnection    |
|   | AS35-X fixed plate                 | L55*W10*H2mm                 | SPCC                              |
|  | Headless inner hexagon screw       | M5*4mm                       |                                   |
|  | Flat-head inner hexagon screw      | CM5*4mm                      |                                   |

## Optical Parameter

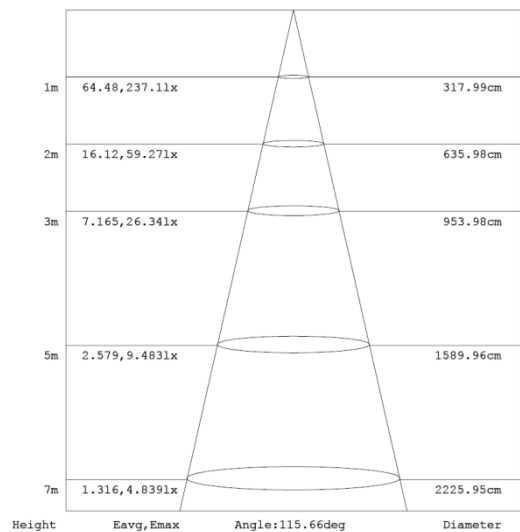
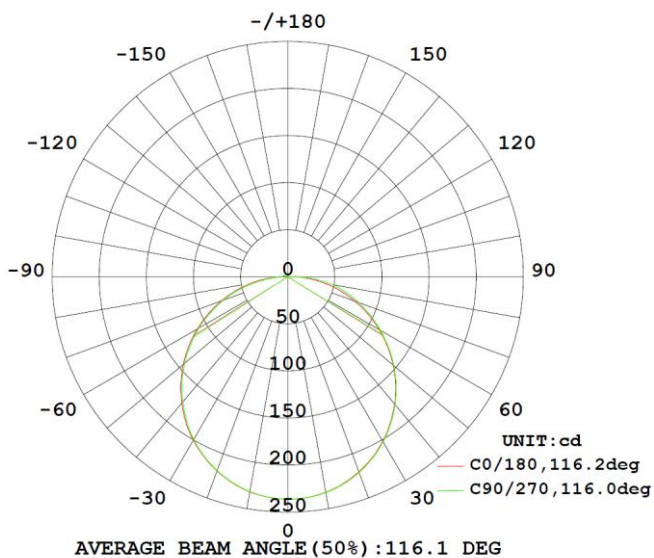

## Package

### 1. Raw Material Packaging

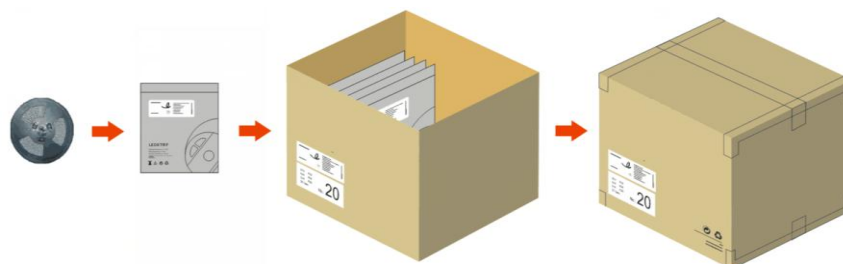

#### Profile Package

| Type           | Size(mm)       | NW(kg) | GW(kg) | Content                   |
|----------------|----------------|--------|--------|---------------------------|
| packing carton | 1130*310*175mm | NA     | NA     | 8 pcs/box ( 90° Profile ) |

#### End cap Package

| Type           | Size(mm)    | NW(kg) | GW(kg) | Content      |
|----------------|-------------|--------|--------|--------------|
| packing carton | 365x365x190 | 14.98  | 16.83  | 1152 set/box |

#### Diffuser package

| Type           | Size(mm)    | NW(kg) | GW(kg) | Content      |
|----------------|-------------|--------|--------|--------------|
| packing carton | 365x365x190 | 13.4   | 14.2   | 5 reel / Box |

#### Extender package

| Type           | Size(mm)    | NW(kg) | GW(kg) | Content     |
|----------------|-------------|--------|--------|-------------|
| packing carton | 365x365x190 | NA     | NA     | 240 set/box |











#### Rigid modular package

| Type           | Size(mm)    | NW(kg) | GW(kg) | Content     |
|----------------|-------------|--------|--------|-------------|
| packing carton | 410x410x260 | NA     | NA     | 30 reel/box |

#### Screw package

| Type           | Size(mm)    | NW(kg) | GW(kg) | Content     |
|----------------|-------------|--------|--------|-------------|
| packing carton | 365x365x190 | NA     | NA     | 192 set/box |

Standard product + flexible customization

| Accessory 1 (raw material packaging) |         |   |   |   |   |   |   |
|--------------------------------------|---------|---|---|---|---|---|---|
| Standard product                     | Item    | Profile   | End cap   | Screw set   | Diffuser  | Extender  | Power supply  |
|                                      | Picture |  |  |    |  |  |  |
|                                      | Amount  | 1 pcs   | 2 pcs/set   | 2 pcs/set   | 20 m/reel   | 10 pcs/set  | 1 pcs/set   |
| Accessory 2 (raw material packaging) |         |   |   |   |   |   |   |
| Standard product                     | Item    | Pendant accessories   | Rigid modular   | Headless inner hexagon screw  | Flat-head inner hexagon screw   |   |   |
|                                      | Picture |  |  |  |  |   |   |
|                                      | Amount  | 2 pcs/set<br>3 pcs/set  | 4.8m/reel   | 200 pcs/set   | 200 pcs/set   |   |   |
| Options                              | NA      |   |   |   |   |   |   |